



Description

LUMICOR's LED Wall Mount Cylinder is Opti-select. Cylinders offer 3 CCT, 3 wattages, 3 beam angles and 3 light modes in only one SKU. D2D photocell can automatically turn off at sunrise or during the day, and automatically light up at sunset or night. It is a highly efficient lighting solution that provides long-lasting and energy-saving. An innovative and flexible wall fixture ideal for facades, entryways and wall washing.

Application

- Entryway
- Awning
- Facade
- Wall washer

Certificate

- UL



3"

4"

6"

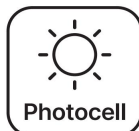

LED Wall Mount Cylinder - LM-WP-29

Key Features

- Innovative Optic Selectable capability accomplished 3 different beam angle (25°/40°/60°) in one fixture.
- DIP switch for Up, Full, Down lighting modes.
- Standard dusk to dawn Photocell On/Off switch.
- 3CCT(3000/4000/5000K) and Wattages Selectable offer SKU reduction.
- Square shell accessory available.
- Die casting Aluminum housing provide excellent heat dissipation.
- Waterproof IP65 rated, wet location.

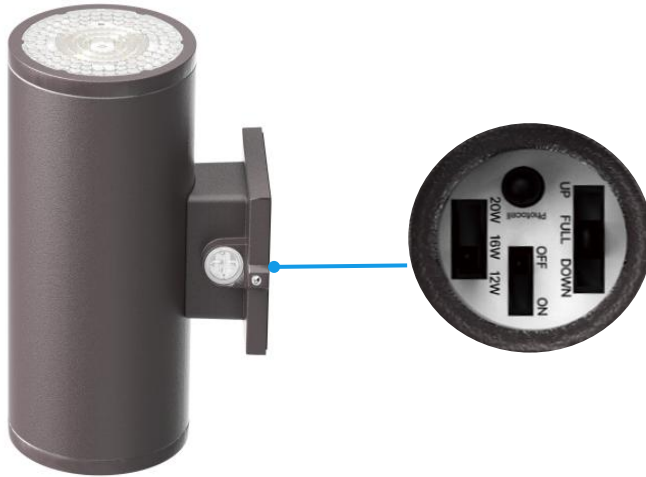

• Field-adjustable Wattage

3 Wattage selectable.

• Photocell ON/OFF

• Light Direction Selection

Up, Full, Down

• Field-adjustable CCT & Beam Angle

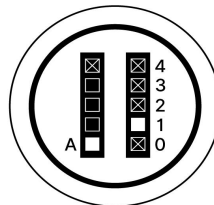
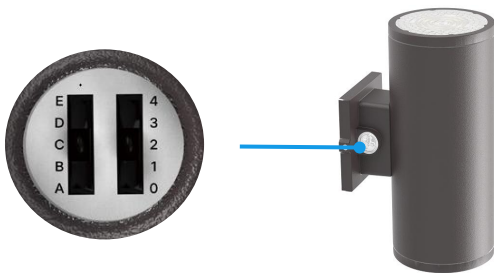

A+1: 3000K 40°
A+2: 4000K 25°
A+3: 5000K 25°
A+4: 3000K 25°

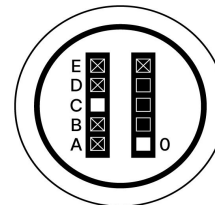

B+0: 5000K 40°
C+0: 5000K 60°
D+0: 4000K 60°
E+0: 3000K 60°

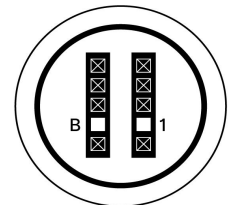

B+1: 4000K 40°
(Factory Default)

• Light Direction Selection

Up, Full, Down

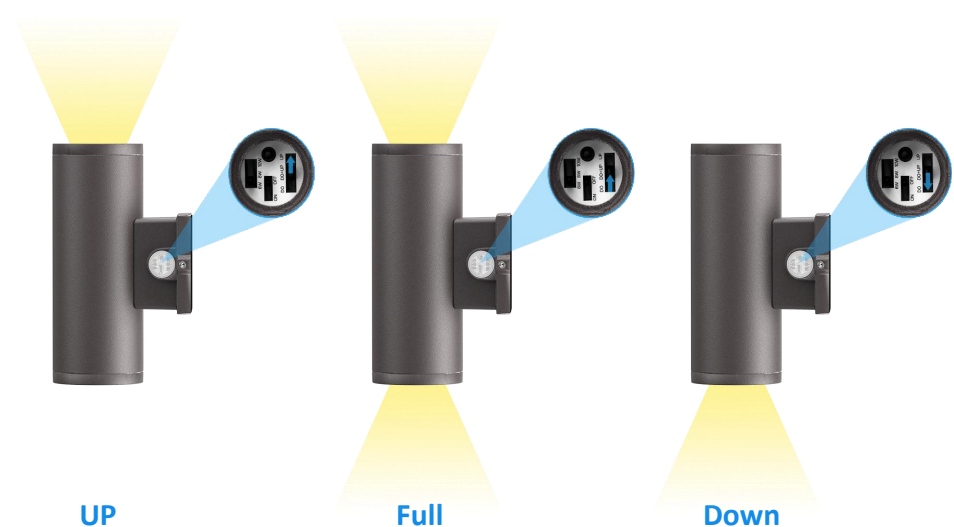

Performance Summary

Model NO. #	Size	Input Watts	Lighting Direction		CCT	LPW	Voltage	DIM	CRI	Beam Angle
			UP watts	Down watts						
LM-WP-29-3-10SW-9D-3CCT	3"	10/8/6W Selectable	10/8/6W	0W	3CCT Selectable 3000K 4000K 5000K	150lm/W	120-347V	0-10V	>80	25/40/60° Selectable
			5/4/3W	5/4/3W						
			0W	10/8/6W						
LM-WP-29-4-20SW-9D-3CCT	4"	20/16/12W Selectable	20/16/12W	0W	3CCT Selectable 3000K 4000K 5000K	150lm/W	120-347V	0-10V	>80	25/40/60° Selectable
			10/8/6W	10/8/6W						
			0W	20/16/12W						
LM-WP-29-6-36SW-9D-3CCT	6"	36/28/21W Selectable	36/28/21W	0W	3CCT Selectable 3000K 4000K 5000K	150lm/W	120-347V	0-10V	>80	25/40/60° Selectable
			18/14/10.5W	18/14/10.5W						
			0W	36/28/21W						

Remarks: 1. All above efficacy and lumens are subject to CRI>80 @4000K @40° @full lighting direction, please check IES files for accurate data.

2. LM-WP-29-6-36SW-9D-3CCT, SW denotes wattage selectable; 9 denotes voltage AC120-347V; D denotes 0-10V dimming.

3. Factory default settings: Photocell is ON, Max wattage, 4000K, 40°, lighting direction is full.

Performance

- LED Type: SMD2835
- THD: 20%
- Power Factor: ≥0.90
- Frequency: 50/60HZ
- IP Rating: IP65
- Surge Protection: L/N 2KV, L/N-P 4KV (10W&20W)
L/N 4KV, L/N-P 6KV (36W)
- Storage Temp.: -40°F to 158°F (-40°C to +70°C)
- Operating Temp.: -35°F to 113°F (-40°C to 45°C)
41°F to 86°F (5°C to 30°C) for EM version





Construction

- Lens: Polycarbonate
- Housing: 6063 Aluminum
- End Caps/Mounting Plate: Die-cast Aluminum
- Finish: Bronze(Standard)

Mounting

- Wall Mount

Accessories (Sold separately)

Picture	Item #	Description
	EMY-04058DO-U1	4W Helpower Emergency driver for 4" and 6" fixture
	ACC-WP29-3-SS	Square shell used on 3" wall mount cylinder, Bronze finish
	ACC-WP29-4-SS	Square shell used on 4" wall mount cylinder, Bronze finish
	ACC-WP29-6-SS	Square shell used on 6" wall mount cylinder, Bronze finish



Product Dimension

(unit: mm & inch)

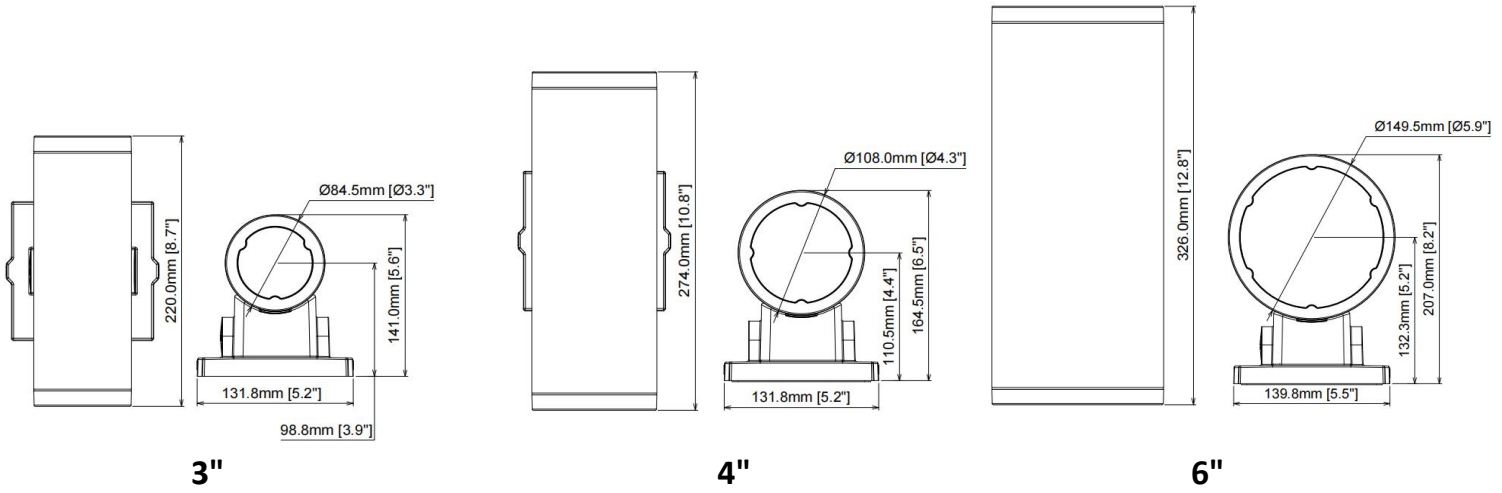

Square Shell Accessory Dimension

(unit: mm & inch)

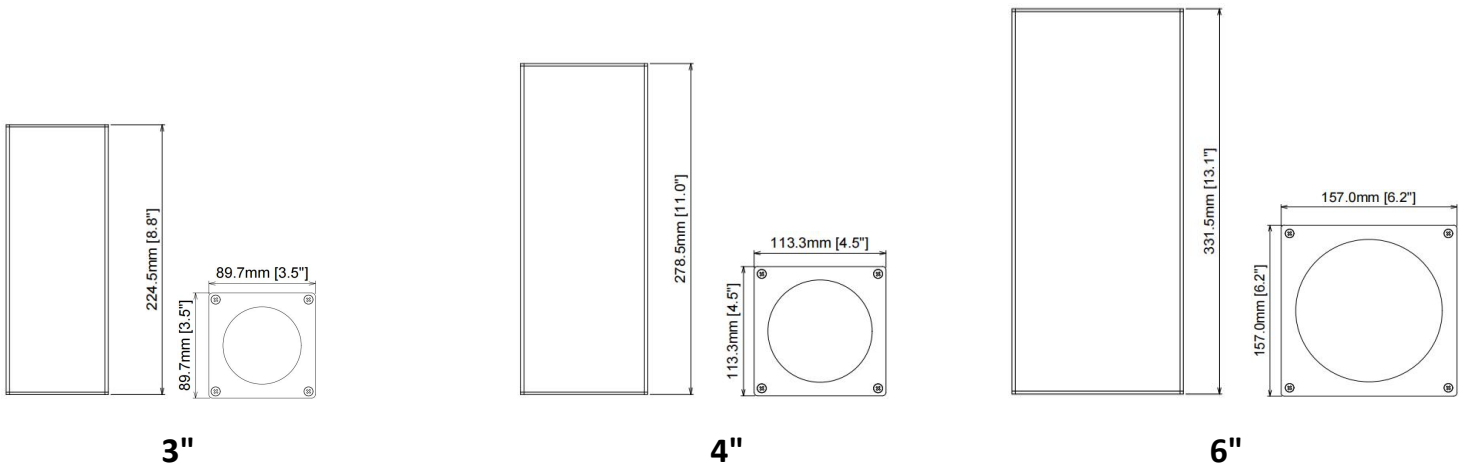

Mounting Plates Dimension

(unit: mm & inch)

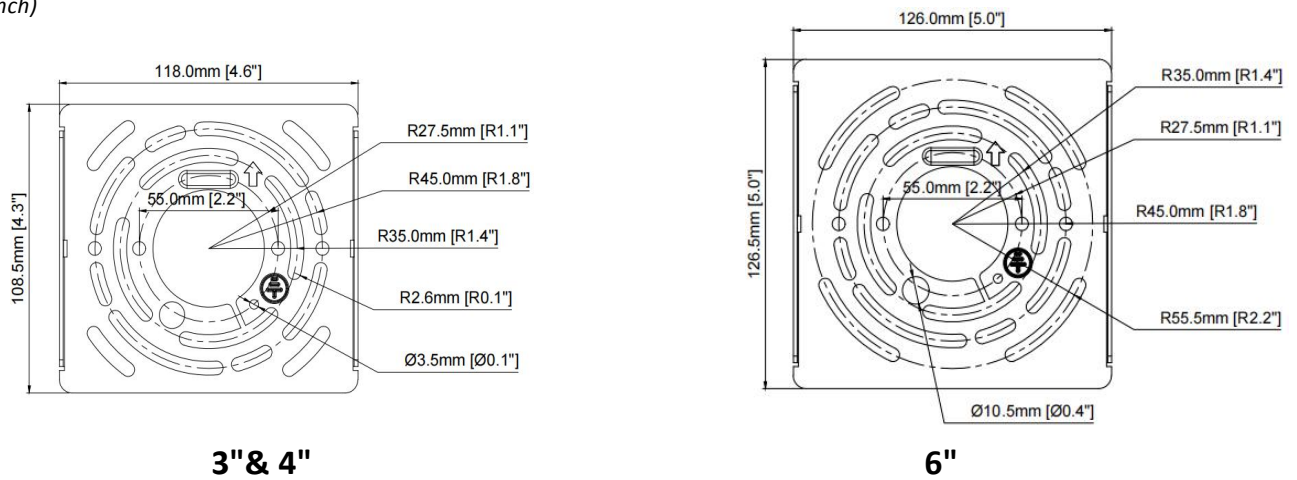

LED Wall Mount Cylinder - LM-WP-29

Packing Info.(Round)

Product Size (inch & mm)	Product & Package Weight(KG)				Carton Size(inch & mm)	Q'ty/BOX (PCS)	Q'ty/CTN (PCS)	20GP (PCS)	40HQ (PCS)
	N.W./PC	G.W./PC	N.W./CTN	G.W./CTN					
3" 5.6"*5.2"*8.7" 141.0*131.8*220.0mm	1.55	1.70	12.40	14.33	18.6"*11.5"*13.0" 472.0*291.0*329.0mm	1	8	4512	10920
4" 6.5"*5.2"*10.8" 164.5*131.8*274.0mm	2.20	2.42	13.20	15.31	16.9"*11.7"*14.8" 430.0*296.0*377.0mm	1	6	3492	7308
6" 8.2"*5.9"*12.8" 207.0*149.5*326.0mm	3.30	3.61	13.20	15.25	13.7"*13.7"*18.2" 349.0*349.0*463.0mm	1	4	1536	3960

Packing Info.(Square)

Product Size (inch & mm)	Product & Package Weight(KG)				Carton Size(inch & mm)	Q'ty/BOX (PCS)	Q'ty/CTN (PCS)	20GP (PCS)	40HQ (PCS)
	N.W./PC	G.W./PC	N.W./CTN	G.W./CTN					
3" 5.6"*5.2"*8.8" 154.0*131.8*224.5mm	2.12	2.27	12.71	14.25	16.93"*9.65"*13.11" 430.0*245.0*333.0mm	1	6	4356	10500
4" 6.5"*5.2"*10.9" 186.5*131.8*278.5mm	3.16	3.39	12.64	14.14	11.81"*11.46"*15.63" 300.0*291.0*397.0mm	1	4	2660	6720
6" 8.2"*5.9"*13" 233.4*157.0*331.5mm	5.59	5.93	11.17	12.42	14.41"*13.86"*9.76" 366.0*352.0*248.0mm	1	2	1728	3960

Packing Info.(Square Shell Accessory Only)

Product Size (inch & mm)	Product & Package Weight(KG)				Carton Size(inch & mm)	Q'ty/BOX (PCS)	Q'ty/CTN (PCS)	20GP (PCS)	40HQ (PCS)
	N.W./PC	G.W./PC	N.W./CTN	G.W./CTN					
3" 5.6"*5.2"*8.8" 89.7*89.7*224.5mm	0.57	0.62	11.38	13.01	19.25"*15.51"*9.76" 489.0*394.0*248.0mm	1	20	11520	27000
4" 6.5"*5.2"*10.9" 113.0*113.0*278.5mm	0.96	1.03	11.53	13.10	19.29"*14.45"*11.89" 490.0*367.0*302.0mm	1	12	5880	13824
6" 8.2"*5.9"*13" 157.0*157.0*331.5mm	2.23	2.40	13.71	15.15	19.76"*13.35"*13.94" 502.0*339.0*354.0mm	1	6	2592	6300