



LM-CL

LM-CLR

LM-CLF

Description

LUMICOR's LED canopy lights are versatile and energy saving fixtures, which are ideal for covered parking area, garages, walkways, and entrances. It comes with CCT and wattage selectable, allowing you to customize the LED light output to best fit your project. These products are energy-efficient replacements of existing surface mount products.

Application

- Covered Parking area
- Garages
- Walkways
- Gas station
- Entrances

Certificate

- UL
- DLC

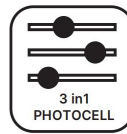

LED GARAGE & CANOPY LIGHT - LM-CL Series

Key Features

- DLC category meet both Canopy & Garage.
- 3CCT(3000/4000/5000K) and 5Wattages Selectable offer SKU reduction.
- 4-in-1 Color Temperature, Power, integrated Photocell ON/OFF, and integrated Occupancy sensor ON/OFF switch.
- 3-in-1 Color Temperature, Power, and integrated Photocell ON/OFF switch.
- Quick installation with flip-open cover.
- Plug-in sensor receptacle and Zhaga sensor receptacle optional.
- 120-277 VAC & 120-347 VAC for options.

Die-cast aluminum housing provides great heat dissipation



Flip-open cover design

Makes mounting to a recessed junction box or conduit entry point both quick and trouble-free.

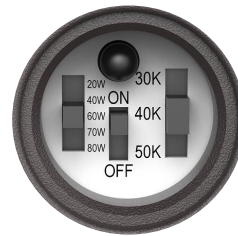

3-in-1 Switch Button

- CCT Selectable
- Wattage Selectable
- Photocell ON/OFF

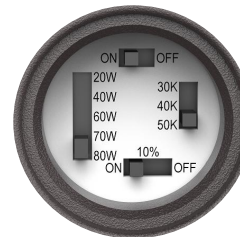

4-in-1 Switch Button

- CCT Selectable
- Wattage Selectable
- Photocell ON/OFF
- Motion sensor ON/OFF



**Microwave Motion sensor/PIR sensor
(not available for LM-CLF)**

LM-CL/LM-CLR: Polycarbonate lens achieve 135° beam angle meet both Canopy & Garage DLC category.

LM-CL: Polycarbonate lens achieve 145° beam angle meet Garage DLC category.

LM-CLF: Polycarbonate lens achieve 110° beam angle meet Canopy DLC category.

LED GARAGE & CANOPY LIGHT - LM-CL Series

Performance Summary

Model NO. #	Watts	CCT	LPW	Lumens(±10%)	Voltage	DIM	CRI	Beam Angle
LM-CL-10-80SW-9D-3CCT	80/70/60/40/20W Selectable	3CCT Selectable 3000K 4000K 5000K	150lm/W	12000lm @80W	120-277V 120-347V	0-10V	CRI>80	135°/145°
LM-CL-10-75SW-9D-3CCT	75/65/55/40/20W Selectable		155lm/W	11600lm @75W				135°/145°
LM-CLR-10-80SW-9D-3CCT	80/70/60/40/20W Selectable		150lm/W	12000lm @80W				135°
LM-CLR-10-75SW-9D-3CCT	75/65/55/40/20W Selectable		155lm/W	11600lm @75W				135°
LM-CLF-10-75SW-9D-3CCT	75/65/55/40/20W Selectable		130lm/W	9750lm @75W				110°

- Remarks: 1. All above efficacy and lumens are subject to CRI>80 @5000K , please check IES files for accurate data.
 2. LM-CL-10-80SW-9D-3CCT-MSP,SW denotes wattage selectable; 9 denotes voltage AC120-347V; D denotes 0-10V dimming
 3. CCT & Power Selectable models ship preset at the highest CCT and the highest wattage.
 4. Factory default settings for Photocell and Microwave motion sensor are ON.

Performance

- LED Type: SMD2835
- Frequency: 50/60Hz
- THD: <20%
- Power Factor: ≥0.90
- IP Rating: IP65
- Operating Temp.: -40°F to 113°F (-40°C to +45°C) for Standard, 32°F to 104°F (0°C to +40°C) for EM version
- Surge Protection: L/N 6KV, L/N-P 6KV for Standard, L/N 1KV, L/N-P 2KV for EM version











Construction

- Lens: Polycarbonate
- Housing: Die-cast aluminum
- Finish: Bronze(Standard), Custom finishes available

Mounting

- Surface Mounting
- Pendant Mounting

Accessories (Sold separately)

Picture	Item #	Description
	ANT-5-4T	Sharkward Plug-in microwave motion sensor (not available for LM-CLF)
	ANT-6-4T	Sharkward Plug-in PIR sensor (not available for LM-CLF)
	ANT-5-4T-BLE-GE	Sharkward Plug-in bluetooth microwave motion sensor (not available for LM-CLF)
	ANT-6-4T-BLE-GE	Sharkward Plug-in bluetooth PIR sensor (not available for LM-CLF)
	ANT-5-ZT	Sharkward Zhaga microwave motion sensor (not available for LM-CLF)
	ANT-6-ZT	Sharkward Zhaga PIR sensor (not available for LM-CLF)
	ANT-5-ZT-BLE-GE	Sharkward Zhaga bluetooth microwave motion sensor (not available for LM-CLF)
	ANT-6-ZT-BLE-GE	Sharkward Zhaga bluetooth PIR sensor (not available for LM-CLF)
	RC-100	Sharkward remote controller (not available for LM-CLF)
	EMB08UY-260	8W Helpower emergency driver (For LM-CL and LM-CLF, not available for LM-CLR)

LED GARAGE & CANOPY LIGHT - LM-CL Series

Integrated Occupancy Sensor Settings

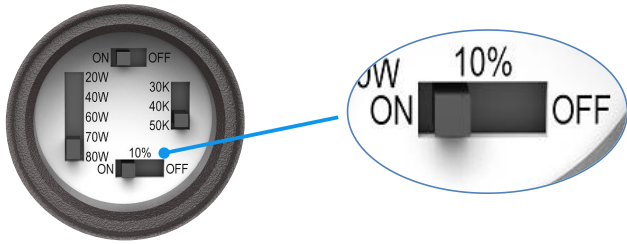

Sensor Datasheet	
Install height	Max 4 meters (13ft)
Detection distance	3-5 meters (10-16ft)
Hold time	10 minutes
Stand by brightness	10% (under 10% Dim Mode)

10% Dim



Switch ON



Switch OFF



10% Dim Mode

The lights turn on when activity/motion is detected. After 10 minutes and no motion has been sensed, the light brightness is 10% lux standby. The minimum wattage is 5W.

Switch ON Mode

The lights turn on when activity/motion is detected. After 10 minutes and no motion has been sensed, the light shuts off completely.

Switch OFF Mode

The motion sensor closed, no motion sensing function.

Product Dimension

(unit: mm & inch)

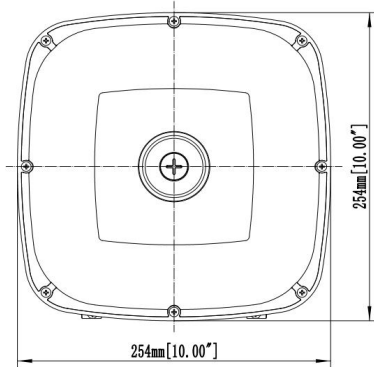

LM-CL

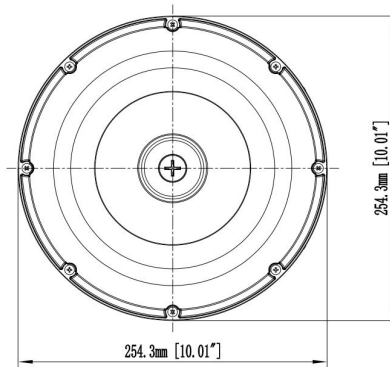
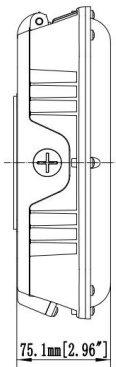

LM-CL

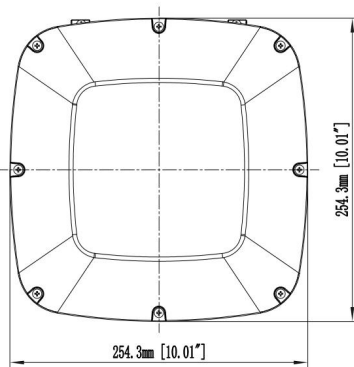
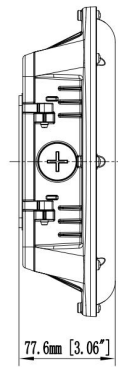

LM-CL

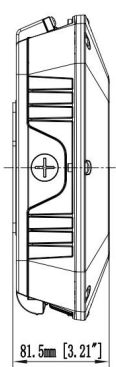

LED GARAGE & CANOPY LIGHT - LM-CL Series

Packing Info.

Product Size(inch & mm)	Product Weight (kg)		Package Weight (kg)		Carton Size(mm)	Q'ty/BOX (PCS)	Q'ty/CTN (PCS)	20GP (PCS)	40HQ (PCS)
	N.W./PC	G.W./PC	N.W./CTN	G.W./CTN					
LM-CL (Standard) 10.00"*10.00"*2.96" 254.0*254.0*75.1mm	2.10	2.40	8.40	10.26	414*286*295	1	4	2968	7072
LM-CL (EM version) 10.00"*10.00"*2.96" 254.0*254.0*75.1mm	2.58	2.88	10.32	12.18	414*286*295	1	4	2968	7072
LM-CLR (Standard) 10.01"*10.01"*3.06" 254.3*254.3*77.6mm	1.90	2.23	7.60	9.40	420*285*280	1	4	3488	8064
LM-CLF (Standard) 10.01"*10.01"*3.21" 254.0*254.0*75.1mm	/	/	/	/	/	1	4	/	/
LM-CLF (EM version) 10.01"*10.01"*3.21" 254.0*254.0*75.1mm	/	/	/	/	/	1	4	/	/