

### Description

LUMICOR's new LED adjustable wall packs are your first choice for wall-mounted lighting projects. Adjustable 0 to 90 degrees beam angles meet different needs. 3 IN 1 switch is selectable for CCT, wattage, and photocell ON/OFF control. D2D photocell can automatically turn off at sunrise or during the day, and automatically light up at sunset or night. It is a highly efficient lighting solution that provides long-lasting and energy-saving.

### Application

- Alleys
- Pathways
- Landscape Lighting
- Outdoor Commercial
- Outdoor Residential

### Certificate

- UL
- DLC

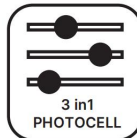

## Key Features

- High efficacy up to 150 lm/W.
- 3CCT(3000/4000/5000K) and 4 Wattages Selectable offer SKU reduction.
- AC120-277V & AC120-347V for options.
- Adjustable beam angle from 0 to 90 degrees, suitable for illuminating specific areas.
- Professional optical design meets the DLC full cut-off wall pack standard.
- ADC12 Aluminum die-casting housing provides excellent heat dissipation.
- Automated Dusk to Dawn photocell functionality.
- Microwave motion sensor and emergency driver available.
- Waterproof rated IP65.

### Adjustable Beam Angle 0-90 degrees

### Die-cast aluminum housing

Durable housing provides good heat dissipation.

### Optical polycarbonate lens

DLC Standard Full cut-off wall pack.

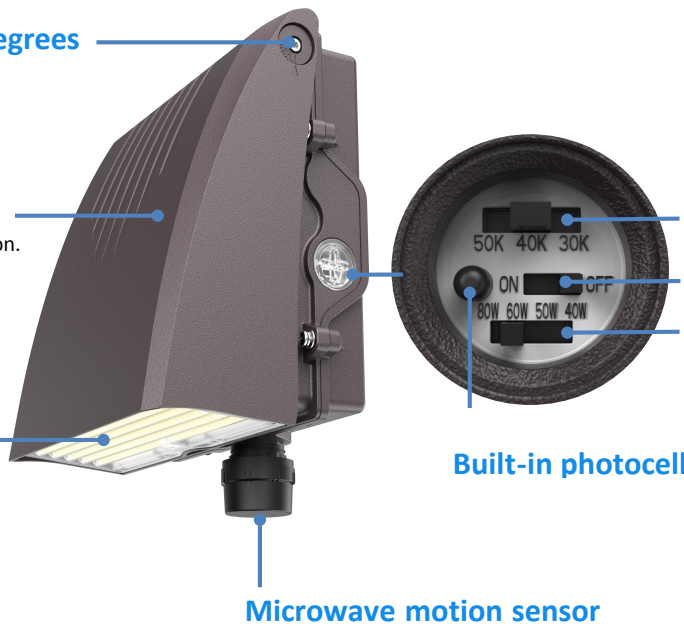

### Field-adjustable CCT

3CCT Selectable: 3000K/4000K/5000K.

### Photocell ON/OFF

### Field-adjustable wattage

4 Wattage selectable.

### Built-in photocell

### Microwave motion sensor

Adjustable beam angle from 0 to 90 degrees, suitable for illuminating specific areas.



0 degree



30 degree



60 degree



90 degree

# LED Adjustable Wall Pack - LM-WP-30

## Performance Summary

| Model NO. #               | Size | Watts                        | 3 CCT   | LPW     | Lumens(±10%) | Voltage                  | DIM   | CRI | Beam Angle |
|---------------------------|------|------------------------------|---|---------|--------------|--------------------------|-------|-----|------------|
| LM-WP-30-8-40SW-9D-3CCT   | 8"   | 15/20/30/40W<br>Selectable   | 3CCT<br>Selectable<br>3000K<br>4000K<br>5000K | 150lm/W | 6000LM@40W   | AC120-277V<br>AC120-347V | 0-10V | >80 | Type III   |
| LM-WP-30-8-80SW-9D-3CCT   | 8"   | 40/50/60/80W<br>Selectable   |   |         | 12000LM@80W  |                          |       |     |            |
| LM-WP-30-10-80SW-9D-3CCT  | 10"  | 40/50/60/80W<br>Selectable   |   |         | 12000LM@80W  |                          |       |     |            |
| LM-WP-30-10-120SW-9D-3CCT | 10"  | 60/90/100/120W<br>Selectable |   |         | 18000LM@120W |                          |       |     |            |

Remarks: 1. All above efficacy and lumens are subject to CRI>80 @4000K, please check IES files for accurate data.

2. LM-WP-30-10-120SW-9D-3CCT, SW denotes wattage selectable; 9 denotes voltage AC120-347V; D denotes 0-10V dimming.

3. CCT & Power Selectable models ship preset at the highest CCT and the highest wattage. Factory default settings for Photocell is ON.

## Performance

- LED Type: SMD2835
- Frequency: 50/60HZ
- Power Factor: ≥0.90
- THD: <20%
- IP Rating: IP65
- Life Time: L70@50,000Hrs
- Operating Temp.: -40°F to 122°F (-40°C to +50°C)
- Surge Protection: L/N 6KV, L/N-P 6KV





## Construction

- Lens: Polycarbonate
- Housing: Die-cast aluminum
- Finish: Bronze, Custom finishes available

## Mounting

- Wall Mount
- Four 1/2" knockouts for convenient installation

## Accessories (Sold separately)

| Picture   | Item #                                   | Description  |
|---|--|--|
|  | ANT-5-ZT                                 | Sharkward Zhaga Microwave Motion Sensor                        |
|  | ANT-5-ZT-BLE-GE                          | Sharkward Zhaga Bluetooth Microwave Motion Sensor              |
|  | HD09VR-MH-1                              | Haisen Plug-in Microwave Motion Sensor                         |
|  | HD09VR-MHB-1                             | Haisen Plug-in Bluetooth Microwave Motion Sensor               |
|  | BLD-YM04S-300A, 4W<br>BLD-YM08S-300A, 8W | Billda Emergency driver, 4W for 8" fixture, 8W for 10" fixture |

## Product Dimension

(unit: mm & inch)

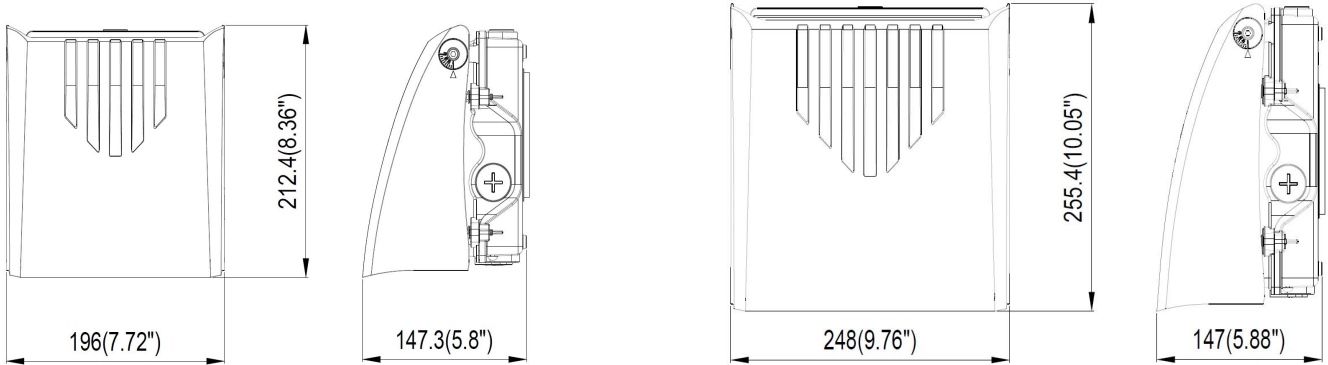

**8"**

**10"**

## Packing Info.

| Product Size(inch & mm)                           | Net Weight/PC | Gross Weight/CTN | Carton Size(mm)                      | Q'ty/CTN (PCS) | 20GP (PCS) | 40HQ (PCS) |
|---|---------------|------------------|--------------------------------------|----------------|------------|------------|
| 8"<br>7.72"*5.80"*8.36"<br>196.0*147.3*212.4 mm   | 1.8           | 2.2              | 9.49"*6.93"*8.66"<br>241*176*220mm   | 1              | 2856       | 6888       |
| 10"<br>9.76"*5.88"*10.05"<br>248.0*147.0*255.4 mm | 2.64          | 3.2              | 11.14"*6.93"*10.71"<br>283*176*272mm | 1              | 1920       | 4704       |