

Description

RDL01 recessed downlight with both circular and square hole sizes, featuring an integrated heat sink module. The front covers are interchangeable and available in Baffle and Bevel, ensuring low UGR visual comfort. Whole series is offered in 3-inch, 4-inch, and 6-inch sizes, making it an ideal for various indoor lighting applications. Constructed from high-quality die-cast alloy aluminum(ADC12), suitable for use in residential and commercial applications.



Application

- Residential areas
- Entryways
- Office
- Retail
- Schools
- Lobbies
- Hallways
- Banquet halls

Certificate

- ETL



Key Features

- Modular minimalist design, with interchangeable square and round trims
- Two trim options available: Baffle and Bevel, providing uniform and soft lighting
- Anti-glare design, with UGR < 19
- Full range of sizes available: 3/4/6 inches, with cutout sizes conforming to standard North American dimensions
- Made of ADC12 aluminum alloy, providing good heat dissipation
- 5 CCT selectable by dip switch
- High color rendering index: CRI 90



3"

RDL01A-3-8W-DC5

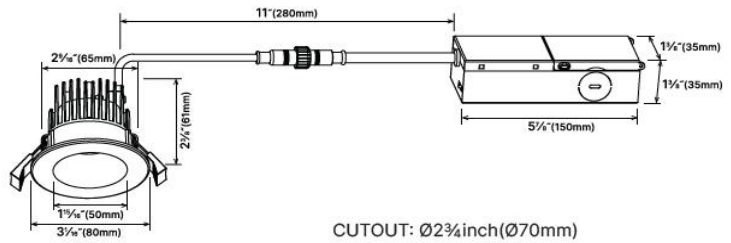

RDL01B-3-8W-DC5

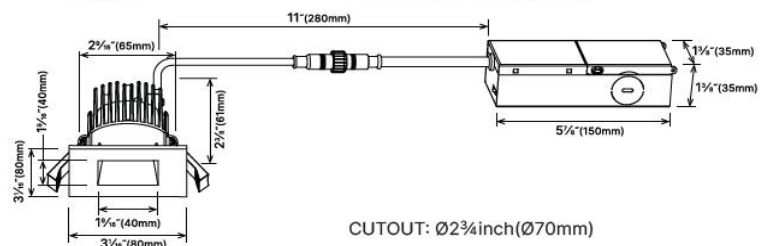

RDL01A-3-15W-DC5

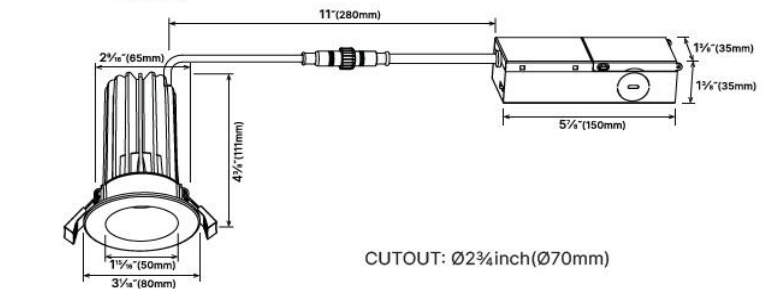

RDL01B-3-15W-DC5

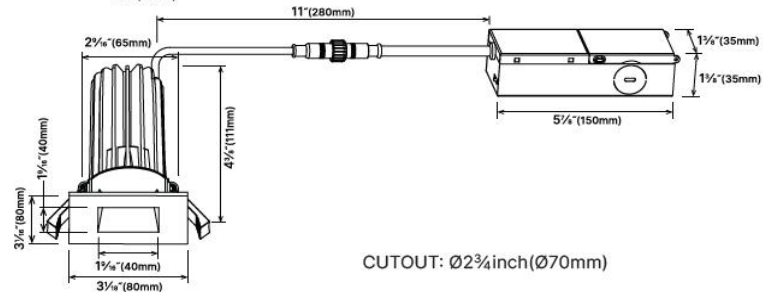

Performance Summary

Model NO. #	Size (inch)	Watts	CCT	LPW	Lumens(±10%)	Voltage	DIM	CRI	Beam Angle
LM-RDL01A-3-8W-DC5	3"	8W	5CCT 2700K	90lm/W	640lm~720lm	120V	Triac	90	36°
LM-RDL01A-3-15W-DC5	3"	15W	3000K / 3500K		1200lm~1350lm				
LM-RDL01B-3-8W-DC5	3"	8W	4000K /	560lm~640lm					
LM-RDL01B-3-15W-DC5	3"	15W	5000K Selectable	1050lm~1200lm					

4"

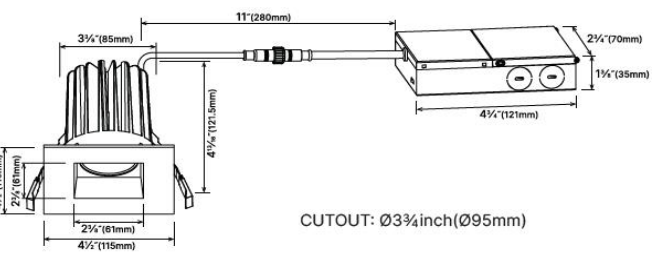
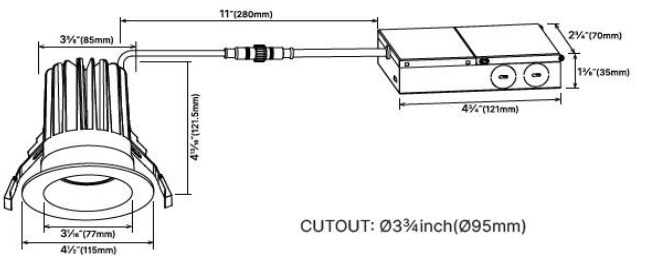
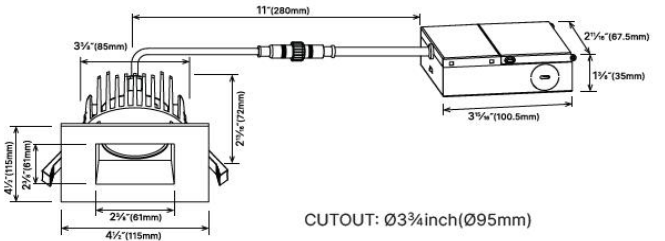
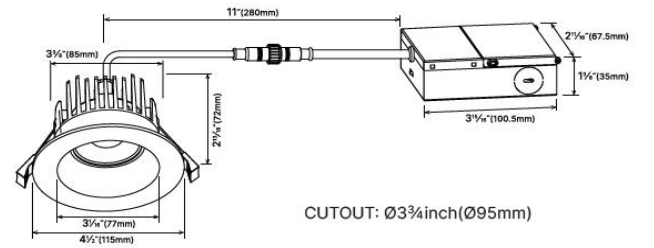
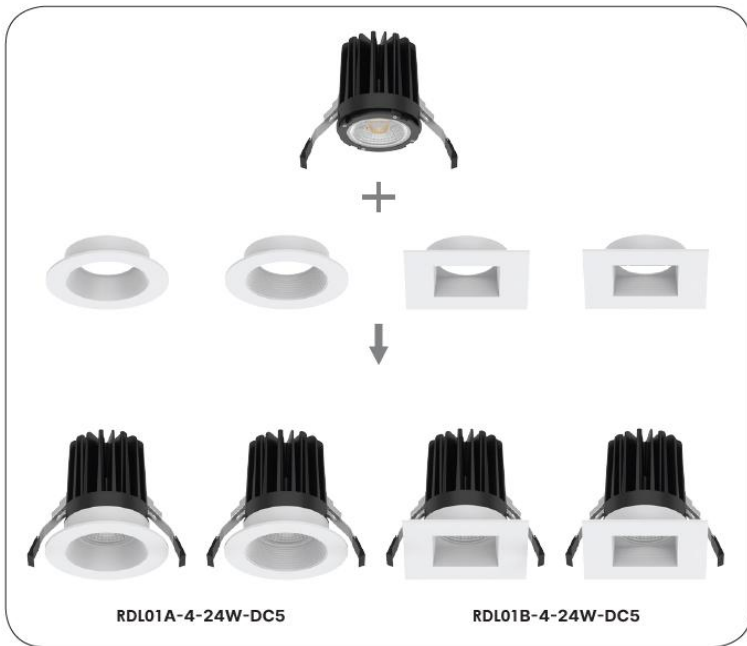
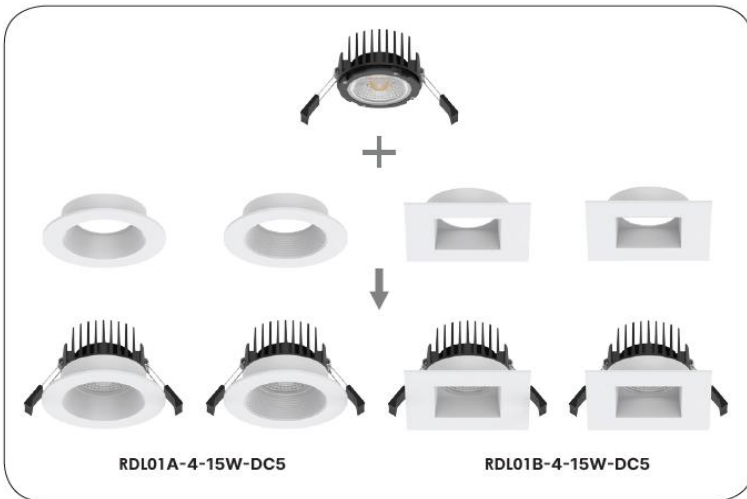

Performance Summary

Model NO. #	Size (inch)	Watts	CCT	LPW	Lumens(±10%)	Voltage	DIM	CRI	Beam Angle
LM-RDL01A-4-15W-DC5	4"	15W	5CCT 2700K / 3000K / 3500K	90lm/W	1200lm~1350lm	120V	Triac	90	36°
LM-RDL01A-4-24W-DC5	4"	24W			1920lm~2160lm				
LM-RDL01B-4-15W-DC5	4"	15W	4000K / 5000K Selectable	80lm/W	1050lm~1200lm				
LM-RDL01B-4-24W-DC5	4"	24W			1680lm~1920lm				

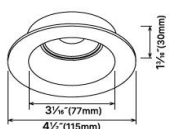

LM-RDL01A-ACC-4-1

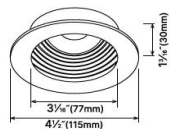

LM-RDL01A-ACC-4-2

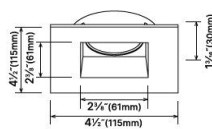

LM-RDL01B-ACC-4-1

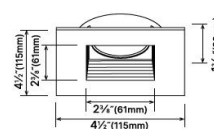

LM-RDL01B-ACC-4-2

6"

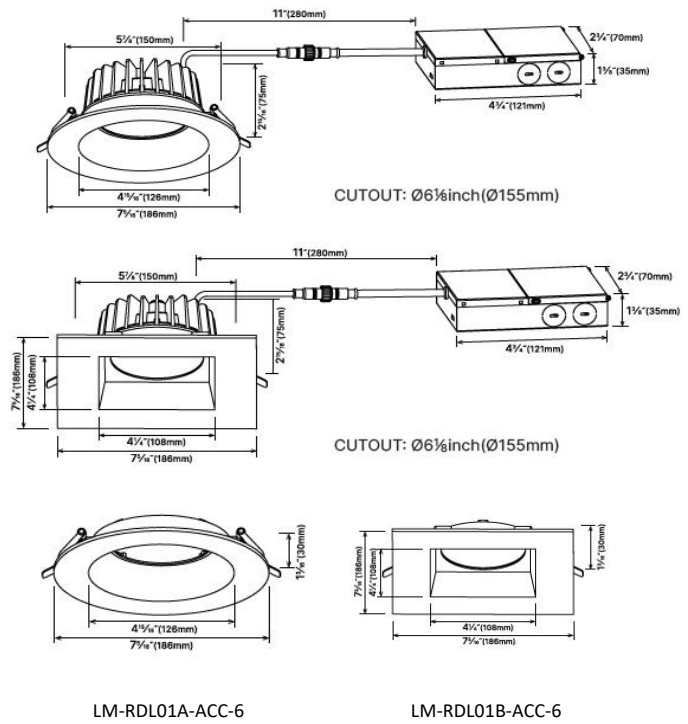

Performance Summary

Model NO. #	Size (inch)	Watts	CCT	LPW	Lumens(±10%)	Voltage	DIM	CRI	Beam Angle
LM-RDL01A-6-24W-DC5	6"	24W	5CCT 2700K / 3000K	90lm/W	1920lm~2160lm	120V	Triac	90	36°
LM-RDL01B-6-24W-DC5	6"	24W	3500K / 4000K / 5000K Selectable	80lm/W	1800lm~1920lm				

Performance

- LED Type: COB
- Frequency: 60Hz
- Dimming: Triac Dimming
- Life Time >50,000 Hrs
- Power Factor: ≥0.90
- Distribution: 36 degree
- Fixture Rating: Damp Location
- Operating Temp.: - 4°F to 113°F (-20°C to 45°C)
- Storage temp: -4°F to 149°F(-20°C to 65°C)
- Dimming compatible controls: Lutron



Construction

- Lens: PMMA
- Housing: ADC12 Aluminum Die Casting
- Finish: White (Standard); Other (Customized)

Mounting

- Recessed Mount

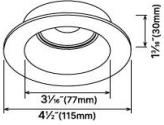
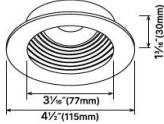
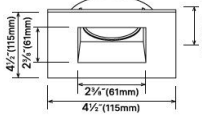
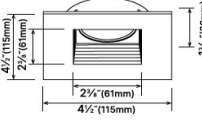
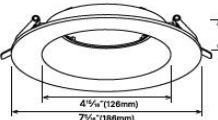
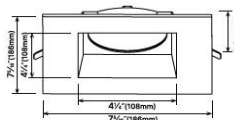
Accessories (Sold separately)

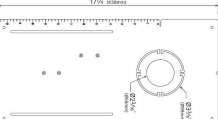
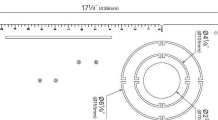
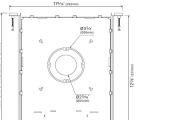
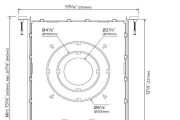
Picture	Model NO. #	Category	Description
	LM-RDL01A-ACC-4-1	Trim module	4" Trim module for RDL01 down light. A-Round Trim and 1- Bevel inner wall.
	LM-RDL01A-ACC-4-2	Trim module	4" Trim module for RDL01 down light. A-Round Trim and 2- Baffle inner wall.
	LM-RDL01B-ACC-4-1	Trim module	4" Trim module for RDL01 down light. B-Square Trim and 1- Bevel inner wall.
	LM-RDL01B-ACC-4-2	Trim module	4" Trim module for RDL01 down light. B-Square Trim and 2- Baffle inner wall.
	LM-RDL01A-ACC-6-1	Trim module	6" Trim module for RDL01 down light. A-Round Trim and Bevel inner wall.
	LM-RDL01B-ACC-6-1	Trim module	6" Trim module for RDL01 down light. B-Square Trim and Bevel inner wall.
	LM-RDL01-ACC-EC-6	Extension Cable	Extension Cable 6FT.
	LM-RDL01-ACC-EC-12	Extension Cable	Extension Cable 12FT.
	LM-RDL01-ACC-2&4-RP	Rough-in plate	Rough-in plate for RDL01 down light 2" & 4" light.
	LM-RDL01-ACC-3&4&6-RP	Rough-in plate	Rough-in plate for RDL01 down light 3" & 4" & 6" light.
	LM-RDL01-ACC-2&4&-NCP	New Construction Plate	New Construction Plate for RDL01 down light 2" & 4" light.
	LM-RDL01-ACC-3&4&6-NCP	New Construction Plate	New Construction Plate for RDL01 down light 3" & 4" & 6" light.

Package Info.

Model NO. #	Product Weight (KGS)		Package weight (KGS)		Master Carton Size (mm&inch)	Q'ty/Inner Box (PCS)	Q'ty/CTN (PCS)	20GP (PCS)	40HQ (PCS)
	N.W/PCS	G.W/PCS	N.W/PCS	G.W/PCS					
LM-RDL01A-3-8W-DC5	0.69	0.73	16.56	17.46	520.7*374.7*295.3 mm 20.50 x 14.75 x 11.63 "	1	24	11088	25344
LM-RDL01A-3-15W-DC5	1.01	1.06	18.25	19.05	425.5*314.3*295.3 mm 16.75 x 12.38 x 11.63 "	1	18	11466	27216
LM-RDL01B-3-8W-DC5	0.69	0.73	16.56	17.46	520.7*374.7*295.3 mm 20.50 x 14.75 x 11.63 "	1	24	11088	25344
LM-RDL01B-3-15W-DC5	1.01	1.06	18.25	19.05	425.5*314.3*295.3 mm 16.75 x 12.38 x 11.63 "	1	18	11466	27216
LM-RDL01A-4-15W-DC5	1.12	1.17	13.49	14.02	485.8*355.6*244.5mm 19.13 x 14.00 x 9.63 "	1	12	4992	18240
LM-RDL01A-4-24W-DC5	1.96	2.01	23.55	24.07	485.8*355.6*325.4 mm 19.13 x 14.00 x 12.81 "	1	12	6216	14592
LM-RDL01B-4-15W-DC5	1.12	1.17	13.49	14.02	485.8*355.6*244.5mm 19.13 x 14.00 x 9.63 "	1	12	4992	18240
LM-RDL01B-4-24W-DC5	1.96	2.01	23.55	24.07	485.8*355.6*325.4 mm 19.13 x 14.00 x 12.81 "	1	12	6216	14592
LM-RDL01A-6-24W-DC5	1.94	1.97	23.23	23.68	469.9*465.3*309.6mm 18.50 x 18.31 x 12.19 "	1	12	4032	9600
LM-RDL01B-6-24W-DC5	2.00	2.03	23.94	24.34	469.9*465.3*309.6mm 18.50 x 18.31 x 12.19 "	1	12	4032	9600
LM-RDL01A-ACC-4-1	0.25	0.31	18.00	22.95	500.8*239.7*385.8 mm 19.69 x 9.44 x 15.19 "	1	72	37080	92880
LM-RDL01A-ACC-4-2	0.28	0.34	20.16	25.11					
LM-RDL01B-ACC-4-1	0.22	0.28	15.84	20.79					
LM-RDL01B-ACC-4-2	0.20	0.26	14.40	19.35					
LM-RDL01A-ACC-6-1	0.64	0.79	15.36	19.87	435.0*395.3*409.6 mm 17.13 x 15.56 x 16.13 "	1	24	8400	20880
LM-RDL01B-ACC-6-1	0.56	0.71	13.44	20.08					
LM-RDL01-ACC-EC-6	0.12	0.13	12.06	13.23	101.6*148.8*140.2 mm 4.00 x 5.86 x 5.52 "	/	100	/	/
LM-RDL01-ACC-EC-12	0.23	0.24	22.93	24.25	101.6*148.8*140.2 mm 4.00 x 5.86 x 5.52 "	/	100	/	/
LM-RDL01-ACC-2&4-RP	0.96	1.06	17.26	19.05	586.6*395.3*265.1 mm 23.06 x 15.56 x 10.44 "	/	18	/	/
LM-RDL01-ACC-3&4&6-RP	0.96	1.06	17.26	19.05	586.6*395.3*265.1 mm 23.06 x 15.56 x 10.44 "	/	18	/	/
LM-RDL01-ACC-2&4&-NCP	0.89	0.97	5.34	5.82	425.5*390.5*314.3 mm 16.75 x 15.38 x 12.38 "	/	6	/	/
LM-RDL01-ACC-3&4&6-NCP	0.89	0.97	5.34	5.82	425.5*390.5*314.3 mm 16.75 x 15.38 x 12.38 "	/	6	/	/